

LINSEIS

THERMAL ANALYSIS

**THERMAL ANALYSIS | THERMO
PHYSICAL
PROPERTIES**



Introduction	3
DSC Differential Scanning Calorimeter	4
HDSC / DTA High Temperature DSC/DTA	6
TGA Thermo Gravimetric Analysis	8
STA Simultaneous Thermal Analysis	10
STA PT 1000	11
STA PT 1600	12
STA PT 1600 High Speed	13
High Pressure STA	14
MSB Magnetic Suspension Balance	15
DIL Dilatometry	16
DIL L 76 PT Horizontal.....	17
DIL L 75 PT Horizontal/Vertical	17
L 78 RITA Quenching/Deformation Dilatometer	18
DIL L 74 Optical Dilatometer	20
L 75 Laser Dilatometer	21
Helium-Cryo-Dilatometer	21
TMA Thermo mechanical Analysis	22
EGA Gas Analysis/Couplings	24
Thermal Diffusivity/Thermal Conductivity	26
LFA Laser Flash	27
TF-LFA Thin Film Laser Flash	28
TFA Thin Film Analyzer	29
HFM Heat Flow Meter	30
THB Transient Hot Bridge	31
LSR-4 ZT-Meter	32
LZT-Meter	33
Hall-Effect	34
Calvet Calorimeter	35

Introduction

Since 1957 LINSEIS has been delivering outstanding service, know how and leading innovative products in the field of thermal analysis and thermo physical properties.

Customer satisfaction, innovation, flexibility and high quality are what LINSEIS represents. Thanks to these fundamentals our company enjoys an exceptional reputation among the leading scientific and industrial organizations. LINSEIS has been offering highly innovative benchmark products for many years.

The LINSEIS business unit of thermal analysis is involved in the complete range of thermo analytical equipment for R&D as well as quality control. We support applications in sectors such as polymers, chemical industry, inorganic building materials and environmental analytics. In addition, thermo physical properties of solids, liquids and melts can be analyzed.

“LINSEIS provides technological leadership.”

We develop and manufacture thermo analytic and thermo physical testing equipment to the highest standards and precision. Due to our innovative drive and precision, we are a leading manufacturer of thermal analysis equipment.

The development of thermo analytical testing machines requires significant research and a high degree of precision. LINSEIS invests in this research to the benefit of our customers.



Claus Linseis
Managing Director

DSC

Differential Scanning Calorimeter

Differential Scanning Calorimetry (DSC) is the most popular thermal analysis technique. It measures endothermic and exothermic transitions as a function of temperature.

The instrument is used to characterize polymers, pharmaceuticals, foods/biologicals, organic chemicals and inorganics. Transitions measured include T_g, melting, crystallization, polymorphism, curing and cure kinetics, onset of oxidation and heat capacity.



DSC

Chip-DSC

The heart of the chip DSC is a metal / ceramic composite sensor, which provides highest sensitivity and resolution at the same time, allowing the instrument to handle applications in the temperature range from -150 to 600°C. In addition, the DSC stands out to an extremely stable baseline and high reproducibility.

The design allows both: manual and automatic measurements. Additionally the measuring cell is designed to the highest level of mechanical and chemical resistance.

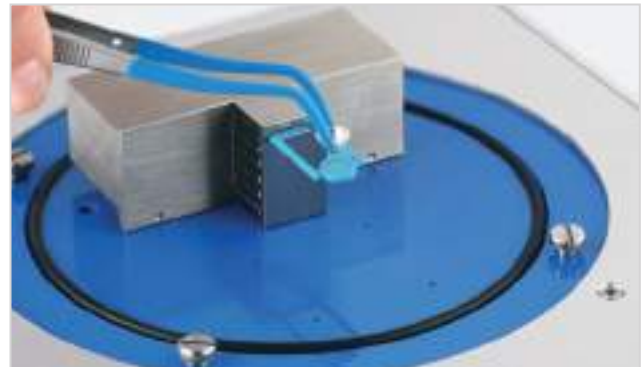

Chip-DSC 100



Chip-DSC 10

highest resolution

unsurpassed sensitivity

user exchangeable sensor

up to 1000°C/min

	Chip-DSC 100	Chip-DSC 10
Temperature range	RT up to 600°C 0 up to 600°C (Peltier-cooling) -100 up to 600°C (Intracooler) -150 up to 600°C (LN ₂ -cooling)	RT up to 600°C -150 up to 600°C (LN ₂ -“Quench“-cooling)
Heating and cooling rates	0.001 up to 1000°C/min	0.001 up to 300°C/min
Temperature accuracy	+/- 0.2K	+/- 0.2K
Temperature precision	+/- 0.02K	+/- 0.02K
Resolution	0.03 µW	0.03 µW
Atmospheres	inert, oxidizing (static, dynamic)	inert, oxidizing (static, dynamic)
Measuring range	+/-2.5 up to +/-250mW	+/-2.5 up to +/-250mW
Calibration materials	included	included
Calibration	recommended 6-month interval	recommended 6-month interval



HDSC/DTA

High Temperature DSC/DTA

High Temperature Differential Scanning Calorimetry (HDSC) expands the temperature range of DSC up to 1750 °C. It is the most popular thermal analysis technique that measures endothermic and exothermic transitions as a function of temperature.

LINSEIS offers a unique line of high temperature DTA and DSC systems.

High Temperature DSC/DTA

High Temperature DSC/DTA PT 1600

This is the most common thermal analysis method due to its wide range of information provided. The LINSEIS high temperature DTA/DSC is designed to deliver highest calorimetric sensitivity, short time constants and a condensation free sample chamber. These features guarantee superior resolution and baseline stability over the entire instrument lifetime. This provides an indispensable tool for material development, R&D and quality control.

The modular concept of the DSC and DTA systems allows the use of different furnaces with a temperature range from -150° up to 2400°C.



DSC PT 1600



DTA

DSC / DSC Cp

3D-Calvet-DSC sensor

The system has different measuring systems for DSC and DTA and many different crucibles. The vacuum tight design enables quantitative enthalpy and Cp (Specific Heat) determination under the cleanest atmospheres and under vacuum up to 10^{-5} mbar. The systems can also be coupled to a MS or FTIR.

sample robot

DTA, DSC, DSC-Cp

-150° up to 2400°C

	DSC PT 1600	DTA PT 1600
Temperature range	-150 up to 500/1000°C RT up to 1400 / 1500 / 1600 / 1650 / 1750°C	-150 up to 500/1000°C RT up to 1400 / 1500 / 1600 / 1650 / 1750 / 2000 / 2400°C
Sensors	DSC-Cp, DSC	DTA
Vacuum	10^{-5} mbar	10^{-5} mbar
Atmospheres	inert, oxid., red., vac.	inert, oxid., red., vac.
Temperature modulation	optional	—
Sample robot	42 positions	42 positions



TGA

Thermo Gravimetric Analysis

Thermogravimetry is a technique in which the mass of the sample is monitored against time or temperature while the temperature of the sample is programmed in a specified atmosphere.

TGA

TGA 1000

The LINSEIS TGA can be used to determine mass changes (TG) of a sample from room temperature to 1100°C. The unique characteristics of this instrument are unsurpassed precision, resolution and long term drift stability. The high speed ceramic furnace enables highest heating and cooling rates with extremely fast temperature changes. Due to the low thermal mass of the furnace there is no temperature overshooting when changing heating or cooling rates.

The optional 42/84 position sample robot in combination with the optional automatic gas control and automatic evacuating system enables long term unattended operation.

The LINSEIS Thermo Balance (TGA) operates in accordance with national and international standards such as: ASTM D3850, E 1131, E 1868, DIN 51006, ISO 7111, ISO11358.



TGA 1000

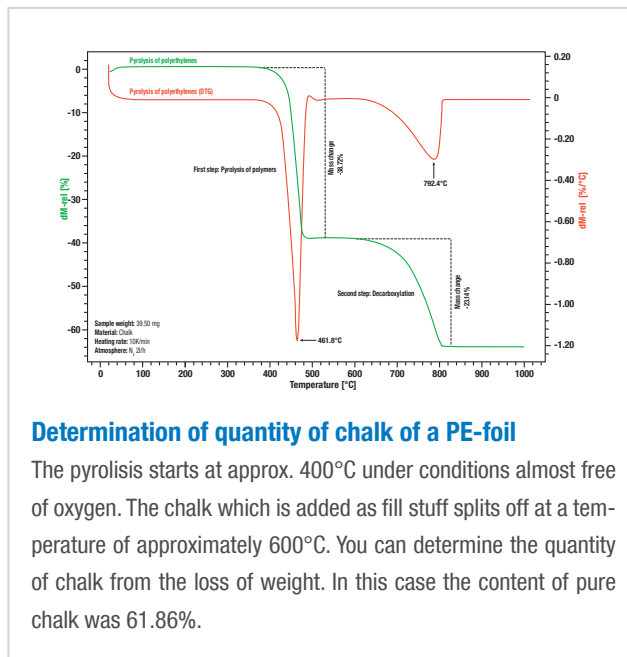

Determination of quantity of chalk of a PE-foil

The pyrolysis starts at approx. 400°C under conditions almost free of oxygen. The chalk which is added as fill stuff splits off at a temperature of approximately 600°C. You can determine the quantity of chalk from the loss of weight. In this case the content of pure chalk was 61.86%.

unsurpassed sensitivity

benchmark resolution

42/84 position auto-sampler

	TGA 1000
Temperature range	RT up to 1100°C
Heating and cooling rates	0.01 to 300°C/min
Sample mass	1 / 5g
Resolution	0.025 or 0.1µg
Vacuum	yes (optional)
Sample carriers	TGA
Sample robot	42/84 positions

STA

Simultaneous Thermal Analysis

Simultaneous TGA-DTA/DSC measures both, heat flow and weight change of a sample as a function of temperature or time under controlled atmosphere. Simultaneous measurement of these two material properties not only improves productivity but also simplifies interpretation of the results. The complimentary information obtained allows differentiation between endothermic and exothermic events which have no associated weight change (e.g., melting and crystallization) and those which involve a weight change (e.g., degradation).



STA PT 1000

STA PT 1000

The LINSEIS STA PT 1000 is a top loading thermo balance, which offers a highly user-friendly design. Even at a sample weight of up to 10 g the Tare is done electronically. The specially designed furnaces allow fast heating and cooling rates as well as a highly precise temperature control. Exchanging the different TGA, DTA or DSC measuring systems is only a question of minutes.

The STA PT 1000 combines both, the sensitivity of a thermo balance and true Differential Scanning Calorimeter. Several different TGA, TGA-DTA and TGA-DSC sample holders can be used to determine different reactions, transition temperatures, enthalpies and specific heat. Static and dynamic atmospheres are possible due to the vacuum tight design of the instrument. Optionally a gas control box and a vacuum pump can be connected. As a result, the system can be adjusted for nearly any type of application.



Applications

- oxidative/thermal stability studies
- composition of multi-component systems
- estimated lifetime of products
- decomposition kinetics of materials
- the effect of reactive atmospheres on materials
- moisture and volatiles content of materials
- transition temperatures
- heats of fusion and reactions
- melting and boiling points

Features

- highest precision TGA/DTA/DSC
- highest resolution
- drift stability
- exchangeable measuring systems TGA-DTA/DSC
- different sensor Types E/K/S/B for highest precision measurements at any temperature
- evolved gas analysis (MS/FTIR) possible
- true DSC sensor for enthalpy & specific heat
- user friendly software

combined TGA-DSC

ultra-high sensitivity

	STA PT 1000
Temperature range	RT up to 1000°C
Sample mass	up to 5 g
Resolution	0.1µg
Measuring system	E/K/S
Vacuum	10 ⁻² mbar
Sample carriers	TG – DTA/DSC
DSC measuring system	E/K/S

STA PT 1600

STA PT 1600

The STA PT1600 is the high end simultaneous thermo balance from LINSEIS. The system offers unparalleled TGA and DSC resolution in combination with the highest vacuum capabilities and TGA drift stability. The system is modular with many exchangeable furnaces, different measuring systems and crucibles. The coupling ability and many optional accessories guarantee the perfect setup for every application.



STA PT 1600

The STA PT 1600 combines both, the sensitivity of a thermo balance and a true Differential Scanning Calorimeter. Several different TGA, TGA-DTA and TGA-DSC sample holders can be used to determine different reaction and transition temperatures, enthalpies and specific heat. As a result, the system can be perfectly adjusted for any type of application. Due to the vacuum tight design of the instrument, static and dynamic atmospheres are possible even at temperatures up to 2400°C. Optionally a gas control box and a vacuum pump are available, as well as an autosampling unit for up to 42 sample positions.

The evolving gases can be analyzed with our integrated QMS, FTIR or GCMS or even in-Situ EGA coupling options. Read more on page 25.

sample robot

simultaneous TGA-DSC

optional pressure

	STA PT 1600/1	STA PT 1600/2	STA PT 1600/3
Temperature range	-150 up to 2400°C	-150 up to 2400°C	-150 up to 2400°C
Vacuum	10 ⁻⁵ mbar	10 ⁻⁵ mbar	10 ⁻⁵ mbar
Pressure	up to 5 bar (optional)	up to 5 bar (optional)	up to 5 bar (optional)
Heating rate	0.01 up to 100°C/min (depends on furnace)	0.01 up to 100°C/min (depends on furnace)	0.01 up to 100°C/min (depends on furnace)
Temperature precision	0.01°C	0.01°C	0.01°C
Sample robot	42 (optional)	42 (optional)	42 (optional)
TGA			
Resolution	0.025µg	0.1µg	0.1µg
Sample weight	5g	25g	35 / 50 / 100g
Measuring range	± 25 / 2500mg	± 25 / 2500mg	±17500 / 25000mg
DSC			
DSC-sensor	E / K / S / B / C	E / K / S / B / C	E / K / S / B / C
DSC-resolution	0,3 / 0,4 / 1 / 1,2µg	0,3 / 0,4 / 1 / 1,2µg	0,3 / 0,4 / 1 / 1,2µg
Calorimetry sensitivity	approx. 4 / 6 / 17,6 / 22,5µW	approx. 4 / 6 / 17,6 / 22,5µW	approx. 4 / 6 / 17,6 / 22,5µW
DTA			
DTA-resolution	0.05µg	0.05µg	0.05µg
Sensitivity	1.5µV/mW	1.5µV/mW	1.5µV/mW
DTA-Measuring range	250 / 2500µV	250 / 2500µV	250 / 2500µV

Sensors

Our STA can be equipped with an unmatched amount of different user exchangeable TGA-DSC, TGA-DTA or TGA sensors.

Each sensor is available with different thermocouples to provide the highest sensitivity for your desired temperature range.

- Al₂O₃
- Platinum
- Alumina
- others

TGA-DSC

DSC Heat flux

3D-Calvet-DSC sensor

Different crucibles available / broad variety

TGA

TGA-hang- down wire

Wheel

TGA-DTA

Cap

Crucible

DTA-sensor

Mesh

12.0 ml

5.0 ml

3.0/0.3 ml

0.14 ml

custom volume

0.12 ml

TGA-sample holders for many different applications

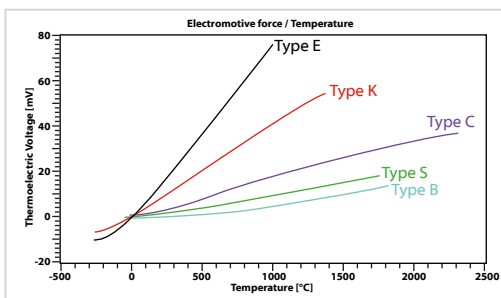

Highest sensitivity for your application

All sensors available with the thermocouples illustrated. LINSEIS Sensor combinations cover the broadest temperature range in the market (-180 up to 2400°C).

High Pressure STA

High Pressure STA

This system provides information about the material composition under the influence of temperature and very high pressure.

It simultaneously measures both, the heat flow (DSC) and weight changes (TGA) in a material as a function of temperature or time in a controlled atmosphere. Simultaneous measurement of these two material pro-

erties not only improves productivity but also simplifies interpretation of the results. The information obtained allows differentiation between endothermic and exothermic events which have no associated weight change (e.g. phase transition) and those that involve a weight change (e.g. degradation). One often used application is the examination of coal gasification processes under different atmospheres and pressures.

The High Pressure LINSEIS STA (simultaneous thermal analysis) delivers unsurpassed performance. The system can be used to determine simultaneous changes of mass (TGA) and caloric reactions (HDSC) under defined atmosphere and pressure (up to 150 bar) in the temperature range RT...1800°C. This instrument is unique because it is the only available pressure STA worldwide.

The unique characteristics of this product are high precision, high resolution and long term drift stability. The STA Platinum Series was developed to meet the challenging demands of the high temperature and high pressure applications.



HP STA

up to 150 bar / up to 1800°C

the only high-pressure-high-temperature-STA worldwide

	STA HP/1	STA HP/2
Temperature range	RT up to 1000°C -125 up to 1200°C	-170 up to 1400/1600/1800°C
Heating element	Kanthal, metalheater	SiC or Graphite
Pressure range	up to 150bar	up to 100bar
Vacuum	up to 10 ⁻⁴ mbar	up to 10 ⁻⁴ mbar
TGA resolution	0.1µg	0.1/0.5µg
max. sample weight	5/15g	2/15/100g
TG-DTA/DSC measuring systems	E/K/S/C	E/K/S/C
Atmosphere	inert, oxid., red., vac.	inert, oxid.*, red., vac.

**not possible with graphite heater*

Magnetic Suspension Balance – MSB

Magnetic Suspension Balance - MSB

The LINSEIS Magnetic Suspension Balance provides gravimetric measurements in wide temperature and pressure ranges. Measurements under aggressive media can be performed.

The contactless transmission of the sample weight is realized with a levitation magnet and a holding magnet. The levitation magnet consists of a permanent magnet and the holding magnet consists of an electro-

magnet hanging on the balance. The position sensor delivers the actual position of the levitation magnet and the PID controller makes a stable levitation position with the electromagnetic force as the actuating variable. The micro balance can be set up at the environmental condition through the magnetic coupling. The balance, as a result, is protected from high temperatures, pressure, and aggressive corrosive compounds.



MSB

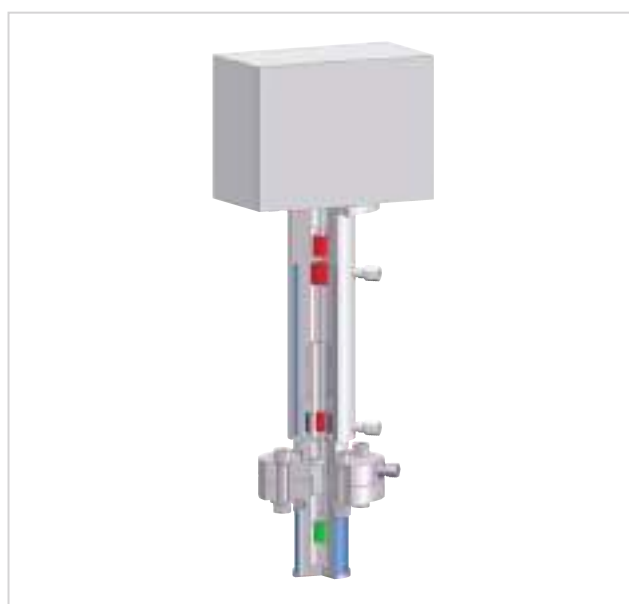

corrosive atmospheres

up to 150 bar

	Metal version	Glass version
Pressure range	UHV to 150bar	vacuum to 1.3bar
Temperature range	-196 up to 2400°C	up to 900°C
Sample weight	10g (standard balance)*	10g (standard balance)*
Resolution	1µg	1µg
Evolved Gas Analysis	MS/FTIR GC/MS optional sniffer coupling without transfer line	MS/FTIR GC/MS optional sniffer coupling without transfer line

**Special custom versions are available!*

DIL

Dilatometry

Dilatometry (DIL) is a technique in which a dimension of a substance under negligible load is measured as a function of temperature while the substance is subjected to a controlled temperature program in a specified atmosphere.

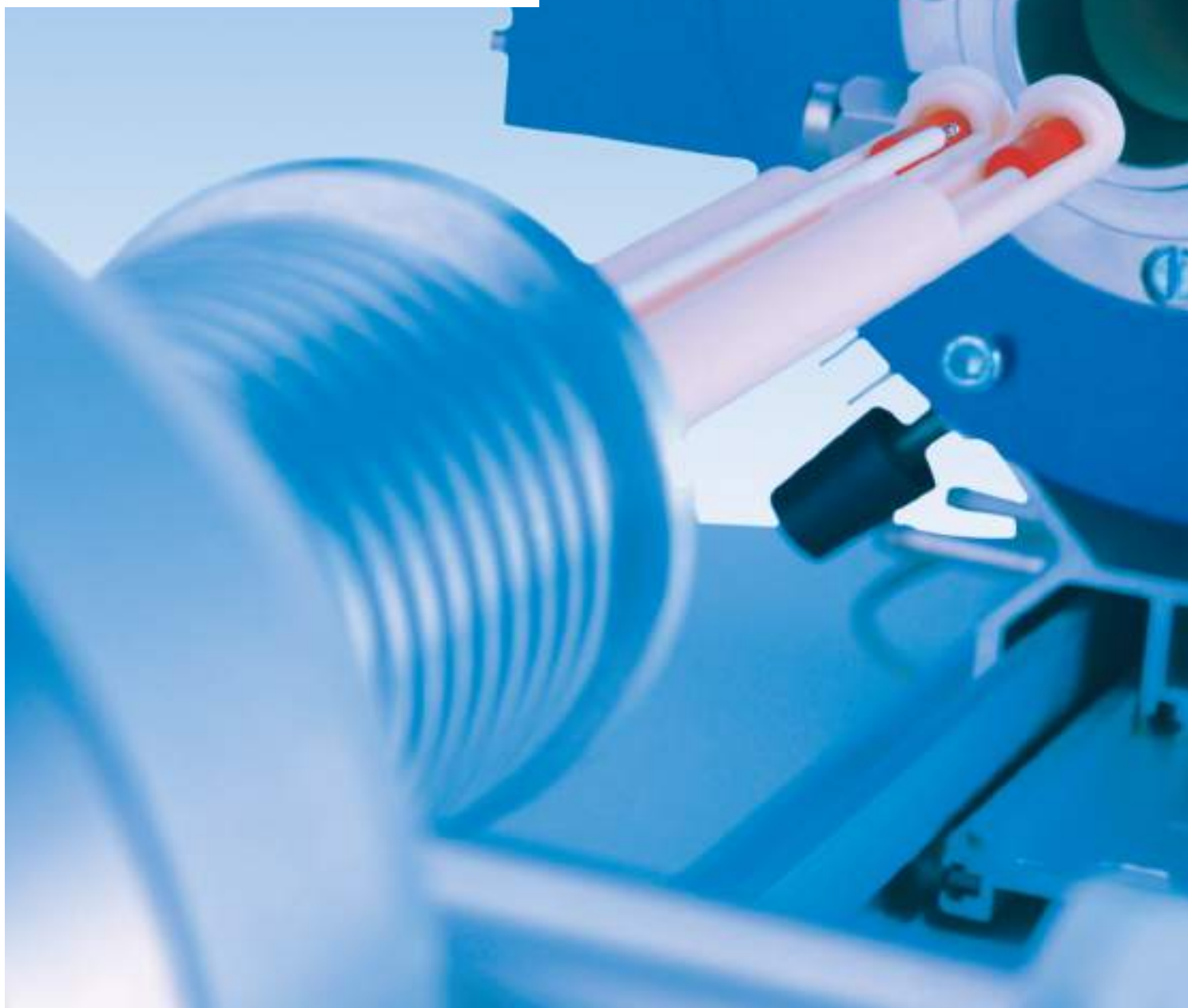

L 76 / L 75

DIL L 76 PT

The LINSEIS Dilatometer series L 76 PT combines user friendliness and high modularity for different applications with outstanding performance in one system. The low cost dilatometer series is especially suitable for the ceramics and glass industry.



DIL L 76 PT

DIL L 75 PT Horizontal / Vertical

The high end vacuum tight pushrod dilatometer solves all measurement tasks when it comes to determining the thermal length change of solids, powders or pastes. The horizontal / vertical design of a single or differential system provides the perfect solution for any type of expansion coefficient and material characteristics measurement.



DIL L 75 PT Horizontal

The thermostatically controlled housing and perfect measuring design allow the highest precision and resolution measurements as well as long term drift stability.



DIL L 75 Vertical

1, 2, 4 or 8 samples

LVDT or Optical Encoder

up to 3 furnaces

	L76	L75 Horizontal	L75 Vertical
Temperature range	RT up to 1600°C	-180 up to 2800°C	-263 up to 2800°C
LVDT			
Delta L resolution	0.05 nm	0.03 nm	0.03 nm
Measuring range	±2500 µm	±2500 µm	±2500 µm
Contact force	—	10 mN up to 1N	10 mN up to 1N
Optical encoder			
Delta L resolution	1 nm	0.1 nm	0.1 nm
Measuring range	±25000 µm	±25000 µm	±25000 µm
Automatic sample length detection	yes	yes	yes
Force modulation	no	yes	yes
Contact force	50mN up to 3 N	10 mN up to 5 N	10 mN up to 5 N
Multiple furnace configuration	optional	up to 2 furnaces	up to 3 furnaces

Quenching Dilatometer L78 RITA/Q DIL

Quenching Dilatometer L78 RITA/Q DIL

The Quenching Dilatometer L78 RITA is especially suitable for the determination of TTT, CHT and CCT diagrams. The special induction furnace allows heating and cooling at controlled speeds in excess of 4000°C/s. The system complies with ASTM A1033.

All critical parameters such as heat up and cool down speed, gas control and safety features are software controlled. The professional LINSEIS TA-WIN software operates exclusively under the Microsoft® operation system. All routine (creation of CHT-, CCT-, TTT-diagrams)

and demanding applications are solved by the unique software package that comes with the instrument.

Export functions in ASCII-format as well as graphic output are available.



Quenching Dilatometer L78 RITA/Q DIL

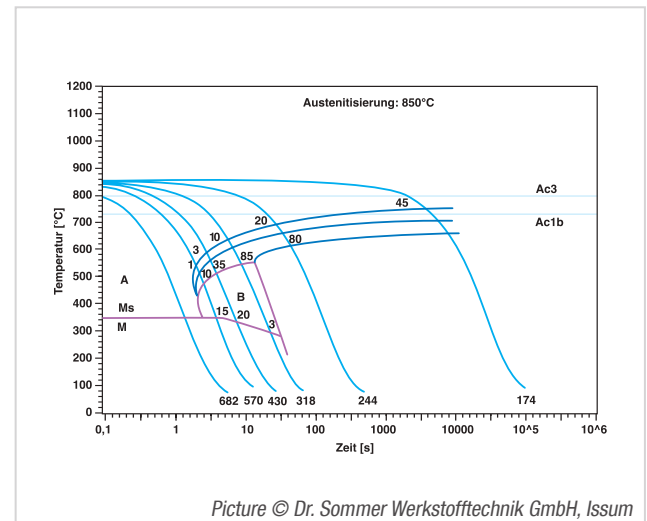

Picture © Dr. Sommer Werkstofftechnik GmbH, Issum

**heating- & cooling rates
up to 4000°C/s**

TTT-, CHT-, CCT-diagrams

	Quenching Dilatometer L78/Q DIL
Temperature range	-150 up to 1600°C
Sample geometry	solid hollow samples
Sample diameter	approx. 5 mm
Sample length	approx. 10 mm
Heating/cooling rates	4000 / 2500°C/s

Quenching/Deformation Dilatometer L78

Quenching/Deformation Dilatometer L78 RITA/Q/D/T

The Quenching and Deformation Dilatometer L78 RITA Q/D/T is especially suitable for the determination of deformation parameters in stress and strain experiments as well as for TTT-, CHT- and CCT-diagrams. The special induction furnace allows very fast heating and cooling at controlled speeds from 2500 up to 4000°C/s. All critical parameters such as heat up and cool down speed, gas control and safety features are software controlled. As a special function, the L78 RITA Q/D/T can provide also various optical detection modes.

The used linear actor mechanical system can realize forces up to 22/25 kN. This allows to achieve deformation rates from 0.01 up to 200 mm/s in single or multiple hits.

The professional software LINSEIS TA-WIN operates exclusively under the Microsoft® operation system. All demanding applications like TTT-, CHT- and CCT-diagrams are solved by this unique software package that comes with the instrument. Export functions in ASCII-format as well as graphic output are available.

TTT-, CHT-, CCT-diagrams

up to 2500 / 4000°C/s

L78 RITA/Q/D/T	Quenching Mode	Tension / Deformation Mode
Temperature range	-150 up to 1600°C	-100 up to 1600°C
Sample geometry	solid and hollow	solid
Sample diameter	ø 3 mm	ø 3 mm
Sample length	10 mm	10 mm
Heating rate	up to 4000 K/s	up to 125K/s
cooling rate	up to 2500 K/s	up to 125K/s
Heating- and cooling rates (combined deformation)		max. up to 100K/s
Tension/deformation force		22/25kN
Deformation rate		0.01 up to 200mm/s
true strain		0.02 to 1.2
Length change measurement	±1,3 mm (resolution 11nm/digit)	±5 mm (resolution 45 nm/digit)
Data sampling rate (temperature, length, force)	up to 1 kHz	up to 1 kHz
minimum pause between two deformations steps		60 ms
Atmospheres		protective gases, vacuum down to 10 ⁻⁵ mbar
Mechanical control modes		stroke, force, stress, strain (optional)



Quenching/Deformation Dilatometer L78 RITA/Q/D/T

DIL L 74 – Optical Dilatometer

DIL L 74 – Optical Dilatometer

The Optical Research Dilatometer L 74 was developed to meet the demanding applications of the glass, ceramics, metal and energy industry. A high resolution CCD camera enables a visual real time analysis of the sample expansion, either as single frame or as video sequences.

The big advantage of this method is that the sample is not burdened with any force. Contact pressure is not distorted for soft samples or samples that melt during the measurement.

Several correction and analysis features are incorporated into the LINSEIS Evaluation Software. The unique horizontal design enables most demanding applications. The special solid-liquid adapter allows expansion / volume measurements of solids, liquids and solid – liquid phase transitions. There is also a special sample holder for measuring rigid foils available, which avoids measurement errors due to pushrod forces like in a classical dilatometer.



DIL L 74

Application

- heating microscope
- optical fleximeter
- non-contact expansion measurement
- sessile drop
- contact angle
- solid-liquid expansion – (optional adapter)

Industries

- glass
- metal
- enamel coatings
- ceramics
- energy

DSC - Option for Optical Dilatometer



	DIL L 74
Design	horizontal
Temperature range	-100 up to 500°C, RT up to 500/1000/1500/2000°C
Measuring system	optical, non-contact
Accuracy	up to 1µm
Atmosphere	oxidizing, (optional: reducing, inert, and vacuum)
Vacuum	10 ⁻⁵ mbar (optional)
Interface	USB
Vacuum	up to 10 ⁻⁵ mbar

L 75 – Laser Dilatometer

Laser Dilatometer

A Laser Dilatometer provides the highest possible accuracy in the measurement of thermal expansion. The Laser Dilatometer outperforms any conventional pushrod dilatometer by offering a 33 times higher resolution. The measurement principle is based on a Michelson interferometer which eliminates all mechanical errors.

Applications

Highest precision expansion measurements of materials such as carbon, graphite, composites materials, glass, alumina, fused silica, substrates, semiconductors, etc.

But the L75-Laser-Dilatometer is also the perfect choice for quality entry control of materials with problematic expansion characteristics like glass, bimetals, precision electronics components, etc.



L75-Laser-Dilatometer

Picometer

	L75 Laser Dilatometer
Method	Laser Dilatometer „Michelson Prinzip“
Temperature range	-180 up to 500°C; RT up to 1000°C
Sample dimensions	up to 20 mm long and up to 7 mm diameter
Resolution	0.3 nm
Atmosphere	inert, oxid., red., vac.

Helium-Cryo- Dilatometer

L75-Cryo-Dilatometer/TMA

The L75-Cryo-Dilatometer offers unsurpassed performance for demanding under very low temperatures. The analyzer is equipped with a closed loop helium cryostat, permitting expansion measurements from -263°C to 220°C in one measurement.



L75-Cryo-Dilatometer

closed loop helium cryostat

-263 to 220°C in one measurement

	L75 Cryo Dilatometer
Temperature	-263 up to 220°C
Mode	Dilatometer or TMA
Element	Helium cryostat
Atmosphere	inert, oxid., red., vac.
Temperature sensor	diode or PT 1000

The image shows a close-up of a Thermo Mechanical Analysis (TMA) instrument. The device is composed of various metal parts, including a large cylindrical chamber, a sample stage, and various sensors and actuators. The entire scene is bathed in a blue light, creating a high-tech, scientific atmosphere. The focus is sharp on the mechanical details, showing the precision of the equipment.

TMA

Thermo Mechanical Analysis

Thermo Mechanical Analysis (TMA) measures linear or volumetric changes in the dimensions of a sample as a function of time, temperature and force in a controlled atmosphere.

TMA

TMA PT 1000

The Thermo Mechanical Analyzers TMA PT 1000 and TMA PT 1000 EM inimitably combine the flexibility of several measurement procedures under changing requirements. The instrument can measure expansion and deformation at highest precision.

The TMA combines all benefits of a standard dilatometer with the additional opportunity of setting stress and strain forces or pressure from certain angles to the sample. So the resulting data can show not only the expansion or shrinkage of materials but also its behavior under the influence of several forces.



TMA PT 1000

TMA PT 1000	
Temperature range	-150 up to 1000°C -260 up to 220°C
Cryo option	optional: liquid nitrogen
Force	up to 1 or 5.7 N
Frequency	1Hz
Resolution	0.125 nm
Atmosphere	inert, oxid., red., vac.

TMA PT 1600

The TMA PT 1600 offers a broad temperature range (RT up to 1600°C) for all kinds of thermo mechanical investigations.

The system can perform either static or dynamic experiments. Typical materials under investigation are composites, glass, ceramics, metals and polymers.



TMA PT 1600

TMA PT 1600	
Temperature range	-150 up to 500°C RT up to 1400 / 1600°C
Force	1 / 5.7 / 20 N
Frequency	1Hz
Resolution	0.125 nm
Atmosphere	inert, oxid., red., vac.



EGA

Gas Analysis/Coupling

When coupling a Thermal Analyzer with a Quadrupole Mass Spectrometer (QMS), FTIR (Fourier Transformed Infrared Spectrometer) or Gas-Chromatograph Coupled Mass Spectrometer (GCMS) outgassing products can be determined and identified. The signal can then be time wise correlated with the signals received by the Thermal Analyzer and also event triggered analysis of the evolved gases is possible.

With the optional Pulse – Analysis of the outgassings can be quantified using OMS, FTIR as well as GCMS.

Evolved Gas Analysis

The combination of a LINSEIS Thermal Analyzer with FTIR, QMS and GCMS is especially interesting in fields such as polymer analysis, chemical research and also the pharmaceutical industry. The coupling is more than the sum of the separate parts. You can benefit from LINSEIS coupling knowledge and integrated hard- and software concepts.

MS coupling

Range	100 / 200 / 300 AMU
Detector	Faraday and SEV (Channeltron)
Vacuum system	Turbo molecular and diaphragm pump (oil free)
Heating	adapter, heated capillary and QMS
Couplings	DSC, TGA, STA, DIL by heated capillary

FTIR coupling

Wave numbers	7500 370 cm ⁻¹
Resolution	1cm ⁻¹
Heating	transfer line and adapter: up to 230°C
Material transfer line	PTFE (exchangeable)

GCMS coupling

Range (MS)	100/200 AMU
Detector	FID and TCD
GC Column	Various columns available for a broad range of applications
Heating	adapter, heated capillary and volve furnace
Coupling	DSC, TGA, STA, DIL
Method	Online detection and event triggered runs

In-Situ EGA

The LINSEIS EGA provides two different coupling methods: for most applications the standard coupling of heated capillary to an open ended furnace is used. But for highest resolution and sensitivity there is also the option to use the LINSEIS sniffer. This special heated vacuum capillary system is placed inside the furnace very close to the sample to get even ppm traces of evolved gases visible in the connected analyzers.

Main advantages

- direct detection of gas compounds, not only mass numbers
- real time in-situ measurement method
- no intrusion into the measurement system (as for extracting systems)
- no cooling of the analyzed gas
- no condensation of substances with high condensation temperatures
- no equilibrium shifts because of temperature changes
- no contamination of the sample gas in extracting lines
- allows usage of principally all optical gas measurement systems (tested for FTIR, Raman, ELIF, among others)

Overview of proven measuring methods

- FTIR: Fourier Transform Infrared Spectroscopy
Measurement of basic and trace gas components in ppm range, for example H₂O, CO₂, CO, H₂S
IR-active molecules are necessary
- Raman-Spectroscopy
Measurement of basic gas components non polar molecules like H₂ or N₂ are measurable.
- ELIF: Excimer Laser induced Fragmentation
Fluorescence UV-Laser-based method for measuring of gaseous alkaline compounds (for example NaCl, NaOH, KCl, KOH).
- Gas Chromatograph coupled Massspectrometer (GCMS)
Measurement and separation of gas fractions in quality control and purity investigations.
Different detection methods (FID, TCD) allow detection of nearly all possible gases using carrier gases H₂, N₂ and He.

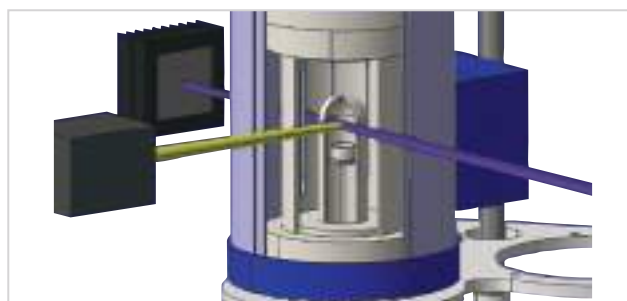



Thermal Diffusivity

Thermal Conductivity

To determine thermal conductivity, thermal diffusivity and specific heat, there are different options, depending on temperature range, type of material and accuracy of the analysis. The most common way to measure thermal diffusivity will be the well known Laser flash method (LFA). Here a sample is pulsed with a Laser and an IR detector on the opposite detects the temperature rise of the sample, what leads to the thermal diffusivity. If the density and specific heat capacity are known, the thermal conductivity can be calculated.

The Transient Hot Bridge method (THB) is made for solids, liquids and pastes and gives the thermal conductivity as direct result of the measurement with high accuracy within a few minutes. It is suitable for isolating materials as well as conductors like metals. The heat flow meter (HFM) is a special instrument for quality control in factories. It needs bigger sample sizes but can measure the thermal conductivity with highest accuracy, using an exact controlled temperature gradient.

For thin film samples and micro samples, known from the computational industries, there are also the new thin film laser flash (TF-LFA) and thin film analyzer (TFA), that can measure the desired thermal conductivity and diffusivity with highest precision as well.

LFA

Laser Flash Analyzer

LINSEIS offers a variety of instruments to measure the Thermal Diffusivity. The LFA 500 provides a cost effective solution for the temperature range from -50 up to 500/1000/1100°C. The highly modular design allows an upgrade to the LFA 1000 system whenever the measurement requires and the budget allows it. The LFA 1000 provides unbeaten sampling rates, up to



LFA 500

18 samples at the same measurement cycle, highest modularity, two different user exchangeable furnaces (-125 up to 1600°C) and two detectors as well as a high vacuum design (10^{-4} mbar).

System Design

LINSEIS is offering an unparalleled modular system design for this Thermo physical properties Analyzer. It is possible to upgrade the temperature range (exchangeable furnaces / measuring system) and the detector (InSb/MCT). This enables the user to start with a cost effective solution and upgrade the system whenever the budget allows or the measurement task requires it.

The LINSEIS LFA operates in agreement with national and international standards such as ASTM E-1461, DIN 30905 and DIN EN 821.

Thermal Diffusivity α

multiple furnaces/turtables

sample robot

	LFA 500	LFA 1000	LFA 2000
Sample dimension	ø 3 / 6 / 10 / 12,7 / oder 25,4mm square samples 10x10 or 20x20 mm	ø 6 - 25,4mm height 0,1 - 6,0 mm	
Max. sample number	up to 18 samples	up to 18 samples	up to 3 samples 1 sample for nuclear version
Temperature range	RT up to 500°C -50 up to 500°C Boost function up to 1450°C (limited furnace lifetime)	RT up to 1000°C	-125 up to 500°C RT up to 2000 / 2800°C
Vacuum	optional	10^{-4} mbar	10^{-4} mbar
Atmosphere	inert, oxid., red., vac.	inert, oxid., red., vac.	inert, vac.
Thermal Diffusivity	0.01 up to 2000 mm ² /s	0.01 up to 2000 mm ² /s	0.01 up to 2000 mm ² /s
Thermal Conductivity	0.1 up to 4000 W/(m·K)	0.1 up to 4000 W/(m·K)	0.1 up to 4000 W/(m·K)
Pulse source	Light Flash variable pulse energy (software controlled)	Nd: YAG Laser variable pulse energy (software controlled)	Nd: YAG Laser variable pulse energy (software controlled)
Pulse energy	10/15 J/Pulse	25 J/Pulse	25 J/Pulse

Thin Film Laser Flash – TF-LFA

High Speed Laser Flash Method

As thermal properties of thin layers and films differ considerably from the properties of the corresponding bulk material a technique overcoming the limitations of the classical Laser Flash Method is required: the “High Speed Laser Flash Method”.

The measurement geometry can be the same as for the standard Laser Flash Technique: detector and laser are on opposite sides of the samples. Because IR-detectors are too slow for measurement of thin layers, detection is done by the thermo reflectance method. The idea behind this technique is that once a material is heated up, the change in the reflectance of the surface can be utilized to derive the thermal properties. The reflectivity is measured with respect to time, and the data received are used to find the matching model which contains coefficients that correspond to thermal properties.



TF-LFA

Front Heating / Front Detection Setup

There is also this second possible setup, called Front Heating / Front Detection (FF). In contrast to usual Laser Flash Setup, the IR detector here is on the same site like the laser is. This is useful for non transparent substrates where the so called RF (Rear Heating, Front Detection) method is not suitable.

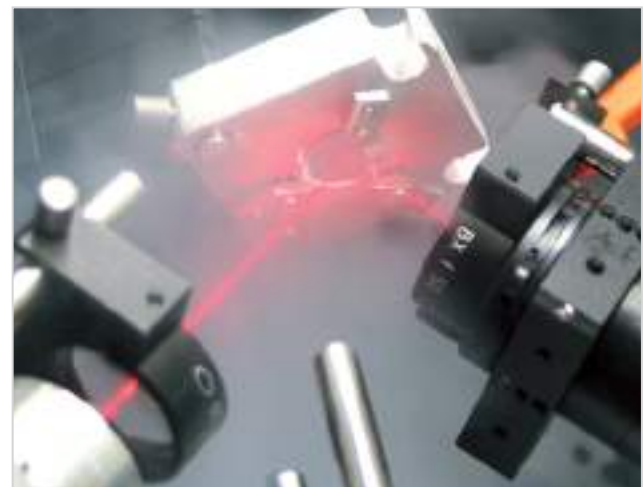
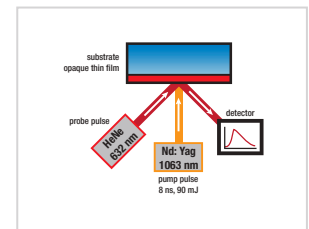
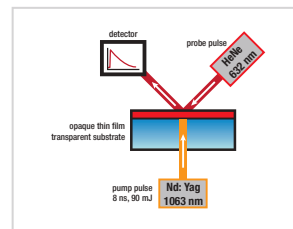

10 nm up to 200 μm

Thin-Film-LFA Specifications

Sample dimensions	Round with a diameter of 10mm to 20mm or square with edges of 10 to 17mm
Thin film samples	10nm up to 20μm
Temperature range	RT, RT up to 500°C or -100 to 500°C
Heating and cooling rates	0.01 up to 10°C/min
Atmosphere	inert, oxidizing, vacuum or reducing
Vacuum	up to 10 ⁻⁶ mbar
Diffusivity measuring range	0,01mm ² /s up to 1000mm ² /s

Thin Film Analyzer – TFA

Thin Film Analyzer – TFA



The LINSEIS Thin Film Analyzer is the perfect solution to characterize a broad range of thin film samples in a very comfortable and quick way. It is an easy to use, single stand alone system that delivers high quality results using an optimized measurement design with proven LINSEIS firmware and software packages.

The big advantage of this system is the simultaneous determination of all interesting physical properties within one measurement run at one sample. Therefore all measured results are very comparable and errors due to different environmental conditions like sample geometry, composition or heat profile are avoided. Another big advantage is the modular system design. If you only want to measure a part of the possible properties, you can start with a basic device and upgrade your system later.

The system can also handle a very broad range of different materials. It is possible to measure samples with metallic behavior as well as ceramics or organics. Therefore, many different deposition methods like PVD, CVD or Spin coating are possible to use.



Following packaging options are available for the LINSEIS Thin Film Analyzer (TFA):

1. Basic device:

Consists of measurement chamber, vacuum pump, basic sample holder with included heater, measurement electronics, PC and LINSEIS Software package. The design is optimized to measure the following physical properties:

- λ - Thermal Conductivity (steady state / in plane)
- ρ - Electrical Resistivity
- σ - Electrical Conductivity
- S - Seebeck Coefficient
- ε - Emissivity

2. Transient package:

Consisting of system integrated lock-in amplifier, electronics and evaluation software for 3ω - method. The design is optimized for measuring the following parameters:

- λ - Thermal Conductivity (transient / in plane and cross plane)
- c_p - Specific Heat

3. Magnetic package:

Selection of integrated electrical magnet, depending on application requirements.

The design is optimized for measuring the following parameters:

- A_H - Hall Constant
- μ - Mobility
- n - Charge carrier concentration

4. Low temperature option for controlled cooling down to 100 K

- TFA/KREG controlled cooling unit
- TFA/KRYO Dewar 25l

-170° up to 300°C

Thin Film Analyzer

3ω , C_p , λ , ρ , σ , S , ε

A_H , μ , n

HFM 300 / 600

LINSEIS HFM 300 / 600

The Heat Flow Meter provides a rapid and easy to use instrument to determine the thermal conductivity properties of low thermal conductivity materials (e.g. like insulating materials) with a high level of accuracy. The instrument is designed for ASTM C518, JIS A1412, ISO 8301 and DIN 12667. The principle of measurement is to position a sample between a hot and a cold plate, and to measure the heat flow.



HFM 300/600

Service and maintenance

The robust system design and the unique “zero maintenance” Peltier heating and cooling cycle ensure a minimum of cost.

Test cycles

The double heat flux sensor configuration ensures shortest possible measurement cycles. A typical measurement for most samples can take as little as 15 minutes until the temperature stabilizes. Two heat flux sensors then measure the heat flow which is precisely defined between the hot and cold plate.

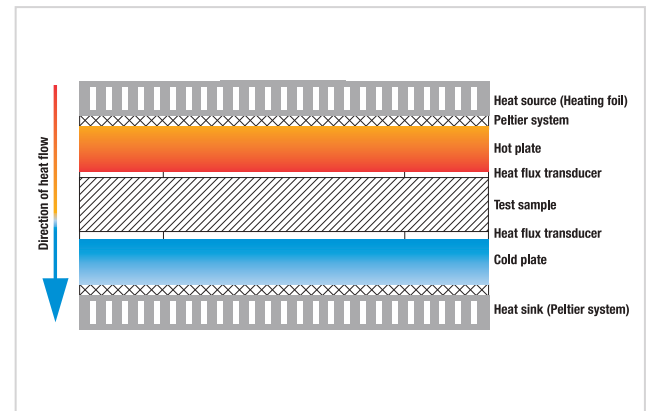

building industry

0.005 – 0.5W/m·K

	HFM 300/1	HFM 300/2	HFM 300/3	HFM 600/1
Temperature range* (Plates)	0 up to 40°C	0 up to 100°C / -20 up to 75°C	-30 up to 90°C	-20 up to 70°C
Cooling system	External Chiller	External Chiller	External Chiller	External Chiller
Temperature control (Plate)	Peltier	Peltier	Peltier	Peltier
Measurement Data Points	1	15	15	15
Sample size	300 x 300 x 100mm ³	300 x 300 x 100mm ³	300 x 300 x 100mm ³	600 x 600 x 200mm ³
Thermal resistance measuring range	0.1 to 8.0m ² K/W	0.1 to 8.0m ² K/W	0.1 to 8.0m ² K/W	0.1 to 8.0m ² K/W
Thermal Conductivity Measuring Range	0.002 to 1.0 W/m·K Extension: 2.0 W/m·K*	0.002 to 1.0 W/m·K Extension: 2.0 W/m·K*	0.002 to 1.0 W/m·K Extension: 2.0 W/m·K*	0.002 to 1.0 W/m·K Extension: 2.0 W/m·K*
Reproducibility	0.25%	0.25%	0.25%	0.25%
Accuracy	+/- 1 to 3%	+/- 1 to 3%	+/- 1 to 3%	+/- 1 to 3%
Variable contact pressure**	0 up to 25kPa	0 up to 25kPa	0 up to 25kPa	0 up to 25kPa

*depends on cooler
**optional

Transient Hot Bridge – THB

Transient Hot Bridge – THB

The Transient Hot Bridge Technique enables thermal conductivity, thermal diffusivity and specific heat measurements on various sample geometries and materials.

This LINSEIS measuring instrument provides the three material properties simultaneously after just a few minutes – regardless of whether you have used the patented sensor in a solid matter (incl. bulk material, gels, pastes) or in a liquid. The preparation of solid samples is pretty simple: One plane surface of two sample halves is sufficient for the sensor. Reference or calibration mea-

surements are a thing of the past. As a matter of course, the THB measures absolute values, with an uncertainty which is not behind that of conventional plate or our laser flash devices.

The THB measures fully automatically and different sensors, easily exchanged, are available for laboratory and field use.

Its software control optimizes the measurement process independently, aiming at a short duration and a minimum uncertainty. In addition, it continuously monitors a possible temperature drift of the sample. Due to the short measurement times, serial measurements can be performed at a forced sequence and with a high sample output.

In addition to the measurement values, the software calculates and displays the associated measurement uncertainties in accordance with the international ISO standard.



THB 100

Thermal Conductivity λ

result in 1 minute

fully automatic

Measuring ranges	THB 1	THB 100	THB 500
Thermal Conductivity	0.01 to 1 W/(m·K)	0.01 to 100 W/(m·K)	0.01 to 500 W/(m·K)
Thermal Diffusivity	0.05 to 10 mm ² /s	0.05 to 10 mm ² /s	0.05 to 10 mm ² /s
Special thermal capacity	100 to 5000 kJ/(m ³ ·K)	100 to 5000 kJ/(m ³ ·K)	100 to 5000 kJ/(m ³ ·K)
Measurement uncertainties			
Thermal Conductivity	better than 2%	better than 2%	better than 2%
Thermal Diffusivity	better than 5%	better than 5%	better than 5%
Special thermal capacity	better than 5%	better than 5%	better than 5%
Duration of the measurement	< 1min	< 1min	< 1min
Service temperature			
Sensor	-150 to 200°C or -100 to 700°C	-150 to 200°C or -100 to 700°C	-150 to 200°C or -100 to 700°C
Sensor type	Kapton and Ceramic insulated sensor	Kapton and Ceramic insulated sensor	Kapton and Ceramic insulated sensor
Sample size			
Smallest sample	2 x 4 mm	3 x 3 x 3 mm	3 x 3 x 3 mm
Sample consistency	solid, liquid, gel, bulk material	solid, liquid, gel, bulk material	solid, liquid, gel, bulk material

LSR-4 ZT-Meter

LSR-4 ZT-Meter (Seebeck-Effect/ Electric Resistivity/Harman-Method)

The thermal power, thermoelectric power, or Seebeck coefficient of a material defines the magnitude of an induced thermoelectric voltage in response to a temperature difference across that material. The Seebeck coefficient has the unit of (V/K).

In recent years much interest has been shown in various methods of direct conversion of heat into electricity. Waste heat from hot engines and combustion systems could save billions of dollars if it can be captured and converted into electricity via thermoelectric devices. For this challenging application Linseis has developed a characteristic evaluating instrument; the LSR-4 "LINSEIS - Seebeck & Electric Resistivity Unit".

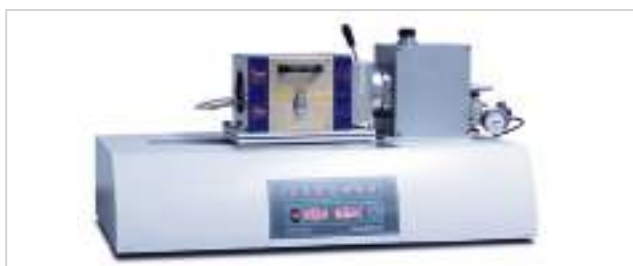

LSR-4 Seebeck

Features

The LSR-4 can simultaneously measure both Seebeck coefficient and electric resistance (Resistivity and ZT with the Harman-Method).

- Prism and cylindrical samples with a length between 6 to 23mm can be analyzed (Prism samples required for Harman-Method)
- Wires and foils can be analyzed with a unique measurement adapter
- Four different exchangeable furnaces cover the temperature range from -100 up to 1500°C
- The design of the sample holder guarantees highest measurement reproducibility

- State of the art software enables automatic measurement procedures

Additionally the infrared furnaces enable very high heating and cooling rates and the advantage of the most accurate temperature regulation according to the set temperature profile.

Principles of Measurement

A sample of cylindrical or prism shape is vertically positioned between two electrodes. The lower electrode block contains a heater, while the entire measuring arrangement is located in a furnace. The furnace surrounding the measuring arrangement heats the sample to a specified temperature. At this temperature the secondary heater in the lower electrode block creates a set temperature gradient. Two contacting thermocouples then measure the temperature gradient T1 and T2. A unique thermocouple contact mechanism permits highest temperature accuracy measurements of the electromotive force dE at one wire of each of the two thermocouples.

The DC four-terminal method is used to measure the Electric Resistance. By applying a constant current (I) at both ends of the sample and measuring the change in voltage (dV) between one wire at each of the two thermocouple pairs.

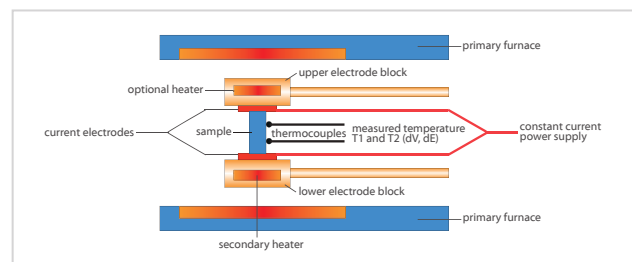

LSR 4

Temperature Range	-100 up to 500°C; RT up to 800/1100/1500°C
Measurement method	Seebeck coefficient: Static DC method Electric resistance: four-terminal method ZT-Measurement: Harman Method
Specimen holder	sandwiched between two electrodes
Atmosphere	inert, oxid., red., vac.
Sample size	2 to 4 mm width and depth x 6 to 23 mm height
Sample size round (Disc shape)	10, 12.7, 25.4 mm
Lead interval	4, 6, 8 mm
Cooling water	included

LZT-Meter (combined LSR/LFA)

Innovative concept of LZT-Analyzer

The first commercial instrument worldwide to measure the Figure of Merit in only one measurement (combining LSR and Laser Flash). The instrument combines three types of measurement: Thermal conductivity, Electric resistivity and Seebeck Coefficient, what means it can unify the function of a LSR with a LFA.

The analyzer is available with different furnace types: the new infrared furnace for most accurate temperature control at very high heating and cooling rates, a low temperature furnace and a high temperature furnace. The included software package provides the possibility to evaluate all measured data in the known easy-to-handle way LINSEIS software is known for and it also provides the Harman-ZT-Model.

Main advantages of all in one measurement:

- same sample
- same geometry
- absolutely identical environmental conditions (humidity, atmosphere)
- temperature program
- possible measurement of high ohmic resistance samples



LZT-Meter

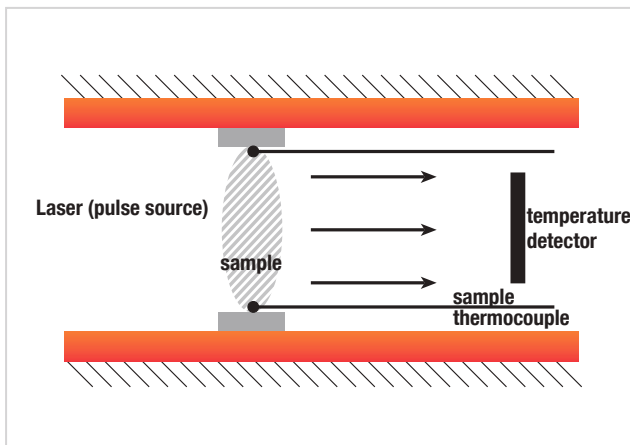

LZT-Meter

Temperature range	-150 up to 500°C; RT up to 600/1100/1500°C
Specimen holder	sandwiched between two electrodes
Atmosphere	inert, oxid., red., vac.
Sample size	2 to 4mm diameter x 6 to 23mm long
Sample size round (Disc shape)	ø10, 12,7, 25,4mm / thickness 4mm
Lead interval	4, 6, 8mm
Cooling water	required
Seebeck	
Seebeck coefficient	Static DC method
Electric resistance	four-terminal method
Thermal Conductivity	
Pulse source	Xenon Pulse: (10 Joule) RT up to 600°C Laser Pulse: (25 Joule) -125 up to 600/1100/1500°C
Pulse duration	0.01 up to 5ms
Detector	Thermocouple or InSb/MCT
Thermal Diffusivity	
Measuring range	0.01 up to 1000mm ² /s

**Thermal Conductivity λ ,
Seebeck-Effect and Electric
Resistivity in one measurement**

combined LFA and LSR

Hall-Effect

L79/HCS-Hall Characterization System

The L79/HCS System permits the characterization of semiconductor devices, it measures: mobility, resistivity, charge carrier concentration and Hall coefficient.

The roughed desktop setup offers different sample holders for various geometries and temperature requirements. An optional low temperature (LN₂) attachments and a high temperature version up to 800°C ensure that all fields of application can be covered. Different permanent and electric magnets provide magnetic fields up to several tesla.

The comprehensive Windows based software provides I-V and I-R Plot. The system can be used to characterize various materials including Si, SiGe, SiC, GaAs, InGaAs, InP, GaN (n Type & p Type can be measured), metal layers, oxides, etc.. Sample testing can be performed to demonstrate the system's capability.



L79/HCS-Hall Characterization System



Features

- Hall Coefficient
- Carrier concentration
- Resistivity
- Mobility
- Conductivity
- Alpha (horizontal/vertical ration of resistance)
- Megneto resistance

Hall constant

mobility

charge carrier concentration

	L79/HCS-Hall
Temperature range	From LN ₂ up to 800°C in different configurations
Input current	500nA up to 50mA
Hall tension	1µV up to 2500V
Max. resolution	65pV
Sample geometry	15 x 15, 20 x 20, 25 x 25mm up to 5mm height
Magnetic field	Permanent magnet 0.75 T Pole diameter 90 mm Two magnet setup for bipolar measurement. Electromagnet up to 1.2 T. Pole diameter up to 76 mm. Power supply 75A / 40V. Current reversal swith for bipolar measurement.
Sensors	different exchangeable sensor configurations available
Resistivity Range	10 ⁻⁴ up to 10 ⁷ (Ω/cm)
Mobility range	1 up to 10 ⁷ (cm ² /Volt sec)
Atmospheres	Vaccum, inert, oxidizing, reducing

Calvet Calorimeter

LINSEIS has developed a new Calvet-type calorimeter which is based on a three-dimensional heatflux sensor. A ring of 680 thermocouples in series surround the sample vessel. The radial arrangement of the thermopiles ensure a high efficient heat transfer. More than 95% of the heat is transmitted through the sensor in the whole temperature range. The sensitivity of the Calvet Calorimeter is not affected by the crucible, the type of purge gas or the flow rate.

With the LINSEIS Calvet Calorimeter the sample volume can be varied in a wide range from 20 µl up to 10 ml without a loss of sensitivity. Solids, liquids, powders, pastes and even highly reactive samples can be measured in various atmospheres and pressures up to 1000 bar.

The instrument can be calibrated electrically which is an absolute calibration without the problems encountered by a calibration performed with a standard material. The calibration can be done at constant temperatures, in heating and cooling mode and for every type of vessel volume. The accuracy of the calibration outperforms Heat Flux and power Compensated Calorimeters.



Calvet Calorimeter

Some of the key benefits of the LINSEIS Calvet calorimeter include:

- The LINSEIS Calvet Calorimeter can be used as a reaction, isothermal and scanning calorimeter.
- Large sample volumes of up to 10 ml can be measured which is important for heterogeneous and multi-component samples
- The results are independent on the weight or form of the samples (solid, liquid, powder, paste etc.)
- A wide range of crucibles from 20 µl to 10 ml can be used. The results are independent on the type of crucible.
- The sample vessels can be adapted to simulate nearly all practical conditions with respect to pressure, temperature, mixing of samples etc.

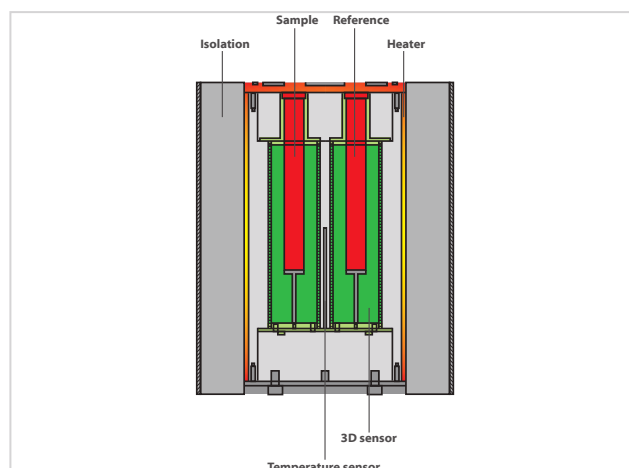

- Highly reactive sample can be measured in glass crucibles without any risk to damage the sensor or instrument.
- The type of uses purge gases and their flow rate do not affect the results.
- The LINSEIS Calvet Calorimeter offers a significantly higher sensitivity compared to Heat Flux or Power DSC instruments which ensures very accurate Cp measurements of solids, liquids and powders.

	LINSEIS Calvet Calorimeter
Temperature Range	RT to 300°C
Temperature Accuracy	± 0.1°C
Heating Rates	0.001 to 5 K/min
Cooling Rates	0.001 to 5 K/min
Calorimetric Precision	± 0.1%
Enthalpy Accuracy	± 1%
Resolution	0.1 µW
Sample Volumes	20 µl to 10 ml
Pressure Vessels	up to 1000 bar

**LINSEIS GmbH Germany**

Vielitzerstr. 43
95100 Selb
Tel.: (+49) 9287-880 - 0
Fax: (+49) 9287-70488
E-mail: info@linseis.de

**LINSEIS Inc. USA**

109 North Gold Drive
Robbinsville, NJ 08691
Tel.: (+1) 609 223 2070
Fax: (+1) 609 223 2074
E-mail: info@linseis.com

**LINSEIS China**

Kaige Scientific Park 2653 Hunan Road
201315 Shanghai
Tel.: +86-21-6190 1202
Fax.: +86-21-6806 3576

**LINSEIS France**

Bureaux Paris
52 Boulevard Sébastopol
75003 Paris
Tel.: (+33) 1 73.02.82.72

**LINSEIS Poland**

ul. Dabrowskiego 1
05-800 Pruszków
Tel.: (+48) 692-773-795

Bureaux Lyon
2A Chemin des Eglantines
69580 Sathonay Village
(+33) 4.26.68.70.55

www.linseis.com

Products: DIL, TG, STA, DSC, HDSC, DTA, TMA, MS/FTIR, In-Situ EGA, Laser Flash, Seebeck Effect, Thin Film Analyzer, Hall-Effect

Services: Service Lab, Calibration Service

05/18

LINSEIS